

MIDMARK®

Installation and Operation Manual

Model 417 Podiatry Treatment Chair



[RETURN TO TABLE
OF CONTENTS](#)

Contents

General Operation and Care of Equipment	3
Important Instructions	4
Unpacking	5
Operation of Table's Features	6
Care of Table	9
Power Systems Maintenance	9

General Operation and Care of Equipment

This manual covers the instructions for the installation, operation, and normal care of the 417 Podiatry Examination Chair.

For the purpose of this manual, the word TABLE is synonymous with the word CHAIR.

This table has been designed to help reduce effort and work fatigue involved in the examination and treatment of an ever-increasing number of patients during the doctor's normal working day.

The angle of the table top, (TILT), and the upper section of the table, (BACK), are adjusted by the use of an electromechanical power unit. The seat height of this table is fixed at 22-1/2". The angle of the table top, (TILT), may be varied from the horizontal to 30 degrees. The upper portion of the table, (BACK), can be adjusted from horizontal to a full chair sitting position, and the foot section may be manually extended - 8-7/8". The combination of these three motions provide a table which can not only be tailored to meet the individual doctor's requirements, but will meet the requirements of most examinations and treatments being performed in the doctor's office today.

The FOOT CONTROL, accessory p/n 9A97002 (optional) and the HAND CONTROL, accessory p/n 9A93001, (standard) both can be used to control manual table adjustments and to enter and use preset programmed positions. They also contain an "auto return" feature which automatically sends the table to a preset, home, sitting position with the single touch of a button.

LIMITED WARRANTY

The Company shall repair or replace any products or parts thereof, which prove to be defective in workmanship and/or material. Except as it may otherwise specifically agree in writing the Company shall not be liable for transportation, labor or other charges for adjustments, repairs, replacement parts, installation or other work which may be done upon or in connection with such products by the Company's authorized Dealers or others.

Any part or parts of a product to be repaired or replaced under this limited warranty must be returned to the factory f.o.b.

This warranty does not apply to any part or product which examination discloses has been misused, abused, altered or tampered with in any way. This warranty shall be in effect for a period of twelve months from the date of shipment to the customer.

In no event shall the Company be liable for consequential or special damages in the event of warranty repair or replacement of its products.

THE FOREGOING IS IN LIEU OF ALL WARRANTIES EXPRESSED OR IMPLIED, AND ALL OTHER OBLIGATIONS OR LIABILITIES ON THE PART OF THE COMPANY.

Important Instructions

Safety First: The primary concern of the Midmark Corporation is that this equipment be operated and maintained with the safety of the patient and doctor in mind. To assure safer and more reliable operation:

1. Read this manual before installing or operating your equipment.
2. It is the responsibility of the purchaser to assure that appropriate personnel are informed on the contents of this manual.
3. Be sure that you understand the instructions contained in this manual before attempting to install or operate this equipment.
4. This manual should remain permanently affixed to the equipment.

Warnings

Throughout this manual are Notes, Cautions, and Danger paragraphs that call attention to particular procedures. The items are used as follows:

NOTE

A note is used to amplify an operating procedure, practice, or condition.



CAUTION

A CAUTION is used for an operating procedure, practice, or condition which, if not correctly followed, could result in equipment damage.



DANGER

A DANGER is used for an operating procedure, practice, or condition which, if not correctly followed, could result in personal injury.

For your personal safety and that of your patients, all DANGER warnings are repeated here. Become thoroughly familiar with them and observe them at all times.

1. Do not lift at point "B", fig. 1. This is not a supported area. Lifting at this point could cause personal injury or damage to the table.
2. Use 115 volt - 60 hertz alternating current only. Failure to do so could result in personal injury or equipment damage.
3. Do not use this table in an explosive or oxygen-enriched atmosphere. Using the table in these situations could cause personal injury or equipment damage.
4. All exposed metal parts of the table are electrically grounded. When performing a cauterization or similar treatment, the patient must be insulated from the metal portions of the table by a nonconductive material. Failure to do so could result in electrical shock or burns to the patient.
5. If the table malfunctions, immediately remove your foot or hand from the control switch, unplug the power cord from the wall receptacle, and assist the patient from the chair.
6. Keep your arms and legs and your patient's arms and legs clear of all moving parts when changing table positions. Failure to do so could result in personal injury.
7. Keep all foreign objects away from the foot switch or hand control so that the switches are not accidentally activated. Failure to do so could result in personal injury or damage to the table.
8. Be sure all persons and equipment are clear of the table before activating the auto return. Failure to do so could result in personal injury or damage to the table.
9. Be sure all persons and equipment are clear of the table before activating any programmed positions. Failure to do so could result in personal injury or equipment damage.
10. Failure to return the foot section or debris tray to its storage position before lowering or auto returning the chair tilt could result in personal injury or equipment damage.
11. Failure to perform a periodic inspection of your equipment could result in personal injury or equipment damage.

Unpacking and Installation

UNPACKING:

To avoid damaging the table when unpacking, do not use a knife or other sharp object to open the carton. To begin, break the bands holding down the carton to the base. Lift carton off the base and remove the poly bag by pulling the staples loose around the skid. Remove the 4 bolts holding the table to the skid at point "A" and lift table up out of the skid by points "C", not at "B".

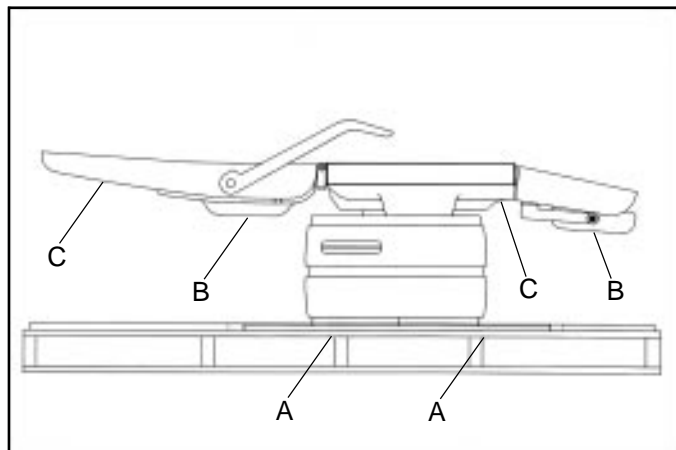

FIGURE 1



DANGER

Do not lift at point "B", fig. 1. This is not a supported area. Lifting at this point could cause personal injury or damage to the table.



DANGER

Use 115 volt - 60 hertz alternating current only. Failure to do so could result in personal injury or equipment damage.



DANGER

Do not use this table in an explosive or oxygen-enriched atmosphere. Using the table in these situations could cause personal injury or equipment damage.



DANGER

All exposed metal parts of the table are electrically grounded. When performing a cauterization or similar treatment, the patient must be insulated from the metal portions of the table by a nonconductive material. Failure to do so could result in electrical shock or burns to the patient.

The table is now ready for operation. If the table does not respond to attempts to move the table using the hand control or foot control, then refer to Reinitialization on page 8.

ELECTRICAL

The electrical rating of the Model 417 is 115 V.A.C., 60 Hertz, 12 Amperes. The three pronged grounding plug on the table power cord must be inserted into a matching three-pronged, grounded, non-isolated, correctly-polarized 115-volt receptacle.

The power cord provides power to all of the table's electromechanical actuators and to both of the duplex receptacles located on lower sides of the seat (A, Fig. 2).

NOTE

This equipment is not designed for continuous operation. If the unit is operated continually, a thermal overload switch will shut off the actuator motor. If normal operation ceases, immediately remove your foot or hand from the control switch. The overload switch will automatically reset after the motor cools (minimum 15 minutes).

The 417 table actuators are fused to protect the operator as well as the table. Should the unit fail to start after a cool down period, contact an authorized service center to investigate the cause of the failure.

Operation of Table Power Features

For optimal performance, allow the table to reach room temperature before operating.

Plug table power cord into proper receptacle as described above under ELECTRICAL.

NOTE

DISABLE SWITCH: A disable switch which interrupts power to all table actuator motors is located beneath the duplex receptacle on the left-hand side of the table (B, Fig. 2).

When the switch is positioned toward the foot end of the table, all controls are disabled. Changing the position of the switch toward the head end of the table allows power to be supplied for table positioning.



CAUTION

Always disable the controls to the table when it is required to remain in a fixed position during cauterization or when the table is left unattended.

CONTROLS ATTACHMENT:

Insert hand control cord into the receptacle of both the table, (C, Fig. 2), and into the receptacle in the bottom of the hand control, (A, Fig. 3). Repeat the process to hook up the foot control, (Fig. 4).

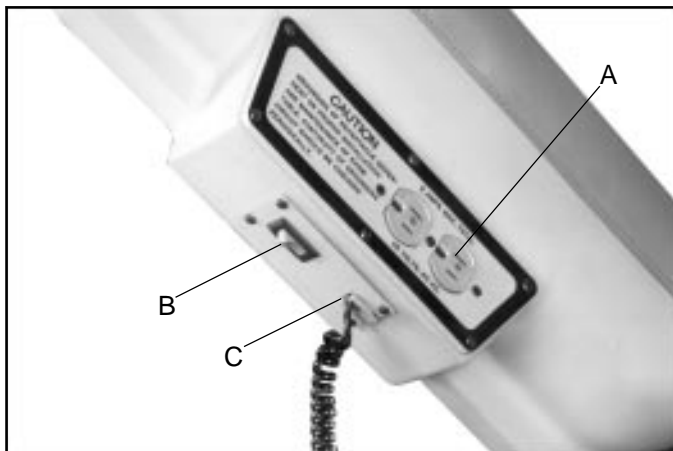

FIGURE 2

To insert plug, align plug tab with notch in the receptacles. Push inward until tab clicks into the locked position. To remove plug, depress tab while pulling on the plug.

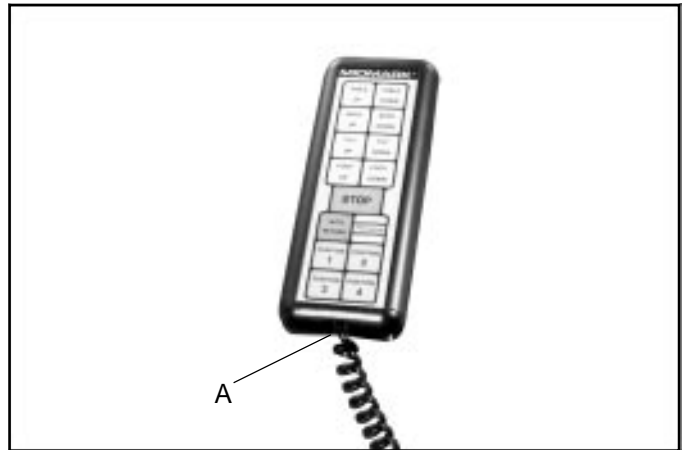

FIGURE 3



FIGURE 4

NOTE

The table may be operated with the hand control connected into the foot control receptacle if so desired, or vice versa.

NOTE

Turn the disable switch toward the head end to power up the table, (B, Fig. 2). Then press the green switch or button marked AUTO RETURN. The table's actuator motors will run then shut down automatically. You may now begin to position the table.



DANGER

If the table malfunctions, immediately remove your foot or hands from the control switch, unplug the power cord from the wall receptacle, and assist the patient from the table.



DANGER

Keep your arms and legs and your patient's arms and legs clear of all moving parts when changing table position. Failure to do so could result in personal injury.



DANGER

Keep all foreign objects away from the hand control or foot switch so that the switches are not accidentally activated. Failure to do so could result in personal injury or equipment damage.



CAUTION

The foot control switches require just 5 lbs. of pressure for activation. Do not apply excessive force to either the foot control switches or the hand control panel, which requires minimal finger pressure.



CAUTION

Do not continue to hold the control switches down after the table reaches either of the extreme positions. Extended operation of the motor at either of these positions will over-heat the actuator motor.

ADJUSTMENT OF TABLE BACK SECTION

To raise the upper portion of the table top from horizontal, depress the arrow-switch or button marked BACK UP and hold down until the desired position is obtained or until the table reaches its maximum amount of movement.

To bring the table top, BACK, down toward horizontal, depress the arrow-switch or button marked BACK DOWN and hold down until the desired position is obtained or the horizontal position is achieved.



CAUTION

Do not continue to hold the control switches down after the table reaches either of the extreme positions. Extended operation of the motor at either of these positions will over-heat the actuator motor.

Patient Positioning (Manual)

The table is now ready for operation. If the table does not respond to attempts to move the table using the hand control or foot control, refer to reinitialization steps on page 8.

Your Model 417 can actuate 3 power motions, TABLE, BACK and TILT.

ADJUSTMENT OF TABLE HEIGHT

To raise the table seat height with either the FOOT CONTROL OR HAND CONTROL, depress the arrow-switch or button marked TABLE UP and hold down until the desired position is obtained or until the maximum height is reached.

To lower the table seat height, depress the arrow-switch or button marked TABLE DOWN and hold down until the desired position is obtained or the minimum seat height is reached.



FIGURE 5

ADJUSTMENT OF THE TABLE TOP ANGLE

To tilt the table top, depress the arrow-switch or button marked TILT UP and hold down until the desired degree of tilt is obtained or until the table reaches the horizontal position.



CAUTION
Do not continue to hold the control switches down after the table reaches either of the extreme positions. Extended operation of the motor at either of these positions will over-heat the actuator motor.



DANGER
Be sure all persons and equipment are clear of the table before activating the auto return. Failure to do so could result in personal injury or equipment damage.

AUTO RETURN

The auto return will lower any amount of table height or tilt and raise the back, moving simultaneously until the table reaches a sitting, patient entry or exit, position. To actuate the auto return, depress the green switch or button marked AUTO RETURN just once.

NOTE
If for any reason the AUTO RETURN must be stopped, press the red switch or button marked STOP or any other switches or buttons in an emergency.

REINITIALIZATION

Depress the PROGRAM, POSITION 1, and POSITION 2 switches simultaneously for a minimum of five seconds. Release these switches and depress the AUTO RETURN switch for seven seconds or until the table begins to move. Release the AUTO RETURN switch. The motors will continue to run for approximately eighteen seconds. The table is now ready for normal operation. If table malfunction persists, then contact your dealer or Midmark's service department at 1-800-MIDMARK.

Patient Positioning (Programmable)

The table is now ready for operation. If the table does not respond to attempts to move the table using the hand control or foot control, refer to reinitialization steps on page 8.

The model 417 table can be programmed to keep up to four doctor specified positions in its computer memory. Once the position is placed in memory, only one switch or button must be activated to simultaneously operate all three power motions of the table. This allows quick positioning for frequently performed procedures.

PROGRAMMING THE TABLE

To store a table position in the computer memory, the following steps must be taken:



DANGER
Be sure all persons and equipment are clear of the table before activating any programmed positions. Failure to do so could result in personal injury or equipment damage.

NOTE
For optimal results, always make certain the table is in its "home," auto returned, position before beginning to enter any programmed positions.

1. Using either the foot or hand control, (Fig. 3 & 5), move the table to the desired position using one function at a time and without starting and stopping each function more than once.
2. Press the yellow switch or button marked PROGRAM once, holding down for 2 or 3 seconds.
3. Next press one of the blue switches or buttons with the number you choose to assign to this position.
4. Press the green switch or button marked AUTO RETURN, allow the table to run to the preset home position.
5. Press the blue, numbered, program switch or button you have just entered and the table will run all actuators simultaneously until the desired position is reached.

NOTE

If for any reason the PROGRAMMED POSITIONING must be stopped, press the red switch or button marked STOP or any other switches or buttons in an emergency.

Should the doctor wish to change a PROGRAMMED POSITION, simply go to the steps listed above. The old position will be replaced by the new.

In the event of a power outage, your model 417 will maintain its memory up to four days after the loss of power.

FOOT SECTION EXTENSION

To accommodate taller patients your table's length can be extended by holding knob, (A, Fig. 6), down while pulling outward on the foot assembly. Releasing the knob automatically locks the foot section into the desired position.

To return the foot section, hold down release knob and push the foot section assembly inward until it rests against the seat.

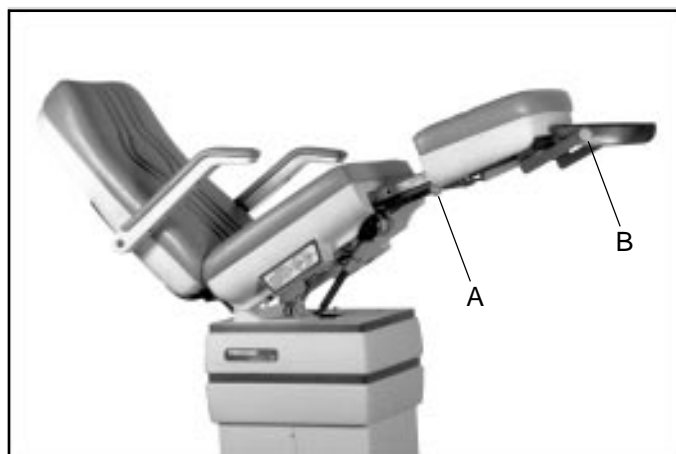

FIGURE 6

DEBRIS TRAY

To expose the debris tray for use, simply pull outward. By loosening the side knobs, (B, Fig. 6), the tray can be positioned parallel to the floor and locked (knobs tightened). To clean the tray, loosen the knobs and turn it over or remove it entirely from the chair by lifting the tray out of the notches in the support arms.



DANGER

Failure to return the foot section or debris tray to its stored position before lowering or auto returning the table could result in personal injury or equipment damage.



FIGURE 7

Care of Table

CARE OF UPHOLSTERY

The upholstery material used to cover the top of the table is resistant to most medicinal-type stains, but may be damaged by solvents and dyes. Regular care should be maintained by daily wiping with a damp cloth or sponge and a periodic cleaning with a mild soap and water solution.

Any fluid spilled on the upholstery should be removed as quickly as possible.

In the case of stain, attempt to remove it with soap and water.

CARE OF PAINTED METAL SURFACES

All painted metal surfaces should be wiped clean with a clean, soft cloth weekly, and a periodic application of paste wax to smooth paints will preserve the finish luster.

CARE OF PLASTIC COMPONENTS

All the plastic table parts should be cleaned with a clean damp cloth weekly. Any soiled areas may be cleaned with soap and water or other household cleaners.

CARE OF MOVING PARTS

All moving parts, such as the foot section slides, back hinges, and debris tray assembly should be lubricated occasionally with a light machine oil to help insure quiet, dependable operation.

Maintenance

Little routine maintenance is required other than a periodic inspection of the electrical cords to make sure they are free of cuts or damage and clear of moving parts. Due to the mechanical, electrical nature of this equipment, periodic inspections at six (6) month intervals by your dealer are recommended.



DANGER

Failure to perform a periodic inspection of your equipment could result in personal injury or equipment damage.

NOTES

RETURN TO TABLE
OF CONTENTS

MIDMARK®

Midmark Corporation, Versailles, Ohio 45380 U.S.A.
937-526-3662 TELEX 288007 FAX 937-526-5542