



DIVAN À HAUTEUR VARIABLE  
HYDRAULIQUE  
VARIABLE HEIGHT HYDRAULIC TABLE

# HYDR



### CONFORT COMFORT

- Dossier réglable par vérin à gaz
- Divan autonome : aucun branchement nécessaire
- Économie d'énergie
- Rapidité en descente
- Possibilité d'adapter de nombreux accessoires
- Gas spring assisted backrest
- Autonomous couch : No connection necessary
- Energy saver
- Fast descent
- Possibility to adapt many accessories

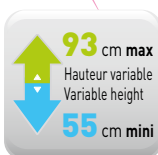

### HYGIÈNE HYGIENE

- Bâti sans aspérité et simple à nettoyer
- Revêtement avec protection antibactérienne (suivant choix de couleur, voir nuancier)
- Support rouleau papier
- Roues de déplacement (en option)
- Frame easy to clean
- Covering with antibacterial protection (depending on the color, see color chart)
- Paper roll holder
- Casters for occasional move (option)



### SÉCURITÉ / SAFETY

- Capacité 200 kg
- Sellerie non-feu M1 (suivant choix de couleur, voir nuancier)
- Absence de risque d'interférences avec les appareils électriques et/ou électroniques
- Compatible dans les Centres Hospitaliers Spécialisés (pas de cordon)
- Capacity : 200 kg
- M1 fire retardant upholstery (depending on the color, see color chart)
  - No interferences possible with electric or electronic appliances
  - Compatible in Psychiatric Hospital (no cords)

### ACCESSIBILITÉ ACCESSIBILITY

- Hauteur variable hydraulique de 55 à 93 cm
- 12 cm de dégagement au sol
- Compatible avec le passage d'un lève-personne
- Variable height from 55 to 93 cm
- 12 cm clearance
- Compatible with a hoist



Accueil  
Welcome



Position haute  
High position



Examen général  
General examination



Avec barrières  
With barriers

## CARACTÉRISTIQUES STANDARD

Hauteur variable hydraulique de 55 à 93 cm  
 Structure acier avec finition époxy gris nuage  
 Dossier réglable par vérin à gaz  
 Patins de réglage sous piètement (réf. 1050-10)  
 Block'n Roll® - Système de roulettes escamotables intégrées semi-centralisé (réf. 1050-15)  
 Support rouleau papier (côté tête) longueur maxi 50 cm - ø 20 cm  
 Poids maximum du patient autorisé 200 kg (testé en dynamique à 250 kg et en statique à 800 kg)

## STANDARD FEATURES

Hydraulic height adjustment from 55 to 93 cm  
 Steel frame structure with light grey epoxy finish  
 Gas-spring assisted backrest  
 Adjustable levellers under base (model 1050-10)  
 Block'n Roll® - Built-in retractable castor system semi centralized (model 1050-15)  
 Paper roll holder (head end) max length 50 cm - ø 20 cm  
 200 kg patient weight capacity (tested at a dynamic weight of 250 kg and a static weight of 800 kg)



Ce produit est un divan d'examen et n'est pas adapté au transfert de patients  
 This is a couch and therefore not allowed for patient transfer

Modèles Models	Patins Levellers	Block'n Roll®
1050-10	●	
1050-15		●

## Selleries Upholstery

Tous modèles, à commander séparément  
 All models, to order separately

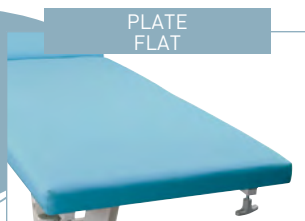

PLATE FLAT  
 Largeur / Width 65 cm..... 600150-65  
 Largeur / Width 75 cm..... 600150-75



A BOURRELETS LATERAL PADDINGS  
 Largeur / Width 65 cm..... 600151-65  
 Largeur / Width 75 cm..... 600151-75



ANATOMIQUE FORMED  
 Largeur / Width 73 cm..... 600150-70

## Options\*

\* A demander impérativement lors de la commande, montage usine  
 Plant installed, must be ordered with initial order



81036  
 4 roues à frein double galets ø 50  
 Set of 4 double castors with brakes ø50 (réf./ref: 1050-10)



2231-65 2231-75  
 Sellerie/upholstery 65 cm Sellerie/upholstery 75 cm  
 Trou pour visage Face cutout in head cushion uniquement sur sellerie plate only with flat upholstery 600150-65 / 600150-75



600000-01  
 Montage de sellerie en usine  
 Factory assembly fitting of upholstery

## Accessoires Accessories



166  
 Paire d'étau  
 Pair of clamps



840+166  
 Paire d'appui-jambes  
 Pair of legrests



850+166  
 Paire d'étriers  
 Pair of stirrups

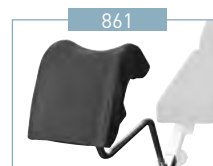

861  
 Paire de housses pour appui-jambes  
 Pair of covers for legrests



2536+166  
 Appui-bras (unitaire)  
 Armrest (unit)



2537  
 Housse pour appui-bras (unitaire)  
 Cover for armrest (unit)



2054-01  
 Appui-tête / Headrest  
 Non compatible avec la sellerie à bourrelets / Not compatible with lateral paddings upholstery

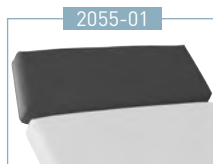

2055-01  
 Rallonge de dossier  
 Backrest extension

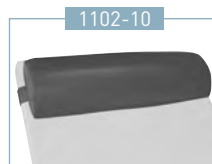

1102-10  
 Appui-tête  
 Headrest



2985-01+166  
 Tige porte-sérum autobloquant 2 crochets  
 Auto-locking 2 hook IV pole

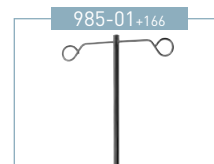

985-01+166  
 Tige porte-sérum 2 crochets  
 2 hook IV pole



85114-01  
 Paire de barrières  
 Pair of barriers  
 Non compatible avec les accessoires / Not compatible with accessories 166, 985-01, 2985-01



2056-02  
 Porte-rouleau réglable (côté tête) / Adjustable paper-roll holder (head-end) (350-800 mm, ø 200 mm)



2057-02  
 Porte-rouleau réglable (côté pied) / Adjustable paper-roll holder (foot-end) (350-800 mm, ø 200 mm)

Choix de selleries non-feu M1  
Antibactérien  
Choice of M1 fire retardant  
and antibacterial upholstery

Classic

- 32 - BLEU / BLUE
- 93 - COTTAGE / COTTAGE
- 35 - ROUGE / RED
- 34 - JAUNE / YELLOW
- 91 - BLANC / WHITE
- 92 - MARINE / MARINE
- 56 - OBSCURE / DARKNESS
- 57 - ANTISTATIQUE / ANTISTATIC  
Non classé M1 / Not classified M1

Vitamin

- 64 - RAISIN / GRAPE
- 67 - LAGON / LAGOON
- 66 - BONBON / SWEET
- 63 - CEDRAT / CEDRAT

Cosy

- 80 - CIEL / SKY
- 81 - VERT D'EAU / SEA GREEN
- 65 - LILAS / LILAC
- 96 - ETAIN / TIN
- 82 - GRIS SOURIS / MOUSE GREY
- 83 - NATUREL / NATURAL
- 84 - CHOCOLAT / CHOCOLATE

ANTIBACTÉRIEN / NON FEU M1 - ANTIBACTERIAL / M1 FIRE RETARDANT



Modèles / Models 1050-10 / 1050-15

Poids net  
Net weight  
82 kg

Poids brut  
Gross weight  
112 kg

Volume  
1,036 m<sup>3</sup>

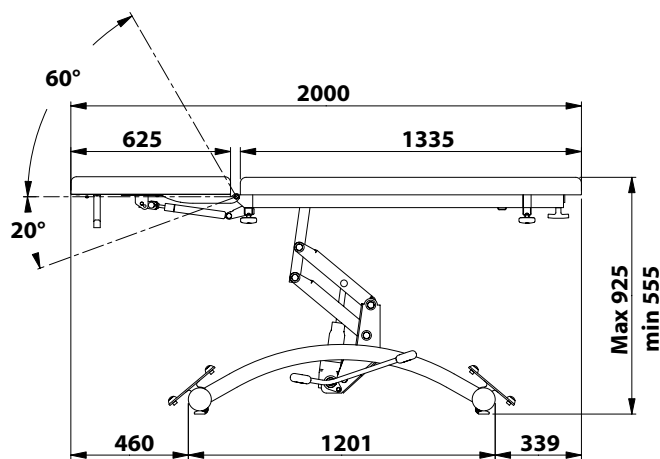
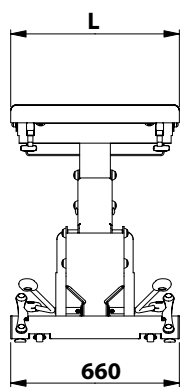

FE-51/16