



DIVAN D'EXAMEN ÉLECTRIQUE
POWER EXAMINATION COUCH

quest[®]



Version : 12-2016



quest®

LA RÉFÉRENCE DES DIVANS À HAUTEUR VARIABLE THE REFERENCE FOR POWER COUCHES

CONFORT COMFORT

- Largeur utile 100 % de la sellerie
- Mouvements électriques doux
- Possibilité de combiner pédale et commande manuelle (3 connections)
- 100 % of the surface usefull
- Smooth electrical motions
- 3 connections possible (possibility to combine hand and foot control)

HYGIÈNE / HYGIENE

- Système Block'n Roll exclusif (modèles 2050-15/30/50)
- Toutes les parties exposées sont accessibles au nettoyage
- Revêtement avec protection antibactérienne (suivant choix de couleur, voir nuancier)
- Exclusive Block'n Roll system (models 2050-10/30/50)
- All exposed parts are cleanable
- Covering with antibacterial protection (depending on the color, see color chart)

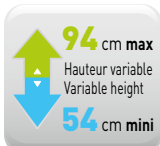

Modèle présenté avec options/accessoires
Products shown with options/accessories

SÉCURITÉ SAFETY

- Pied en H très stable
- Capacité 200 kg
- Proclive - Déclive (sur certains modèles)
- Sellerie non-feu M1 (suivant choix de couleur, voir nuancier)
- Bras d'élévation robustes
- Very stable H shaped base
- 200 kg patient weight capacity
- Trendelenburg - reverse trendelenburg (on specific models only)
 - M1 fire retardant upholstery (depending on the color, see color chart)
 - Sturdy elevation arms

ACCESSIBILITÉ ACCESSIBILITY

- Hauteur variable de 54 à 94 cm
- Compatible avec un lève-malade
- Variable height from 54 to 94 cm
- Compatible with a hoist



Accueil
Welcome



Position haute
High position



Examen général
General examination



Déclive
Trendelenburg



Proclive
Reverse trendelenburg

CARACTÉRISTIQUES STANDARD - modèle 2050-10

STANDARD FEATURES - model 2050-10

Hauteur variable électrique de 54 à 94 cm
 Structure acier avec finition époxy gris nuage
 Dossier réglable par vérin à gaz ou vérin électrique
 Commande manuelle
 Patins de réglage sous piètement
 Block'n Roll® - Système de roulettes escamotables intégrées semi-centralisé (réf : 2050-15, 2050-30 et 2050-50)
 Support rouleau papier (longueur maxi 50 cm - ø 12,5 cm)
 12 cm de dégagement au sol compatible avec le passage d'un lève-personne
 Connexion de 3 commandes possible
 Capacité de charge jusqu'à 200 kg
 (testé en dynamique à 250 kg et en statique à 800 kg)
 Dispositif médical de classe électrique 2 / Disponible en classe 1 avec option 2059-01, non compatible avec 85114-01

Electric variable height from 54 to 94 cm
 Steel frame structure with grey epoxy finish
 Gas-spring assisted or electric backrest
 Hand control
 Adjustable levlers under base
 Block'n Roll® - Integrated retractable castor system semi centralized (ref: 2050-15, 2050-30 and 2050-50)
 Paper roll holder (max length 50 cm - ø 12,5 cm)
 Mobile hoist compatibility clearance of 12 cm
 Possibility of 3 control connections
 200 kg patient weight capacity
 (tested at a dynamic weight of 250 kg and a static weight of 800 kg)
 Electrical medical device class 2 / Available in class 1 with option 2059-01, not compatible with 85114-01

Modèles Models	Patins	Levellers	Block'n Roll®	Proclive / Déclive Tredenlenburg Reverse tredenlenburg	Dossier à gaz Gas-spring assisted backrest	Dossier électrique Electric backrest
2050-10		●			●	
2050-15			●		●	
2050-20		●		●	●	
2050-30			●	●	●	
2050-50			●	●		●

Selleries Upholstery

Tous modèles, à commander séparément / All models, to order separately

PLATE FLAT



Largeur / Width 65 cm..... 600150-65
 Largeur / Width 75 cm..... 600150-75

A BOURRELETS LATERAL PADDINGS



Largeur / Width 65 cm..... 600151-65
 Largeur / Width 75 cm..... 600151-75

ANATOMIQUE FORMED



Largeur / Width 73 cm..... 600150-70

Options*

* A demander impérativement lors de la commande, montage usine / Plant installed, must be ordered with initial order

81036



4 roues à frein double galet ø 50 mm
Set of 4 double castors with brakes ø 50 mm
(réf./ref: 2050-10, 2050-20)

2231-65 2231-75



Sellerie/upholstery 65 cm Sellerie/upholstery 75 cm
Trou pour visage Face cutout in head cushion uniquement sur sellerie plate only with flat upholstery
600150-65 / 600150-75

600000-01



Montage de sellerie en usine
Factory assembly fitting of upholstery

2092



Batterie
Battery

2059-01



Protection terre (classe 1)
Earth socket (class 1)

Accessoires Accessories

166



Paire d'étaux
Pair of clamps

840+166



Paire d'appui-jambes
Pair of legrests

850+166

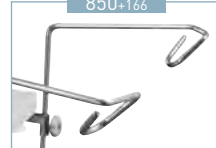

Paire d'étriers
Pair of stirrups

985-01+166

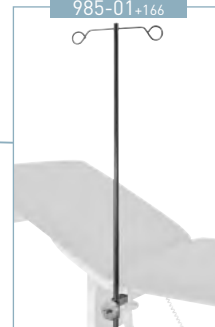

Tige porte-sérum 2 crochets
2 hook IV pole

2985-01+166



Tige porte-sérum autobloquant 2 crochets
Auto-locking 2 hook IV pole

861



Paire de housses pour appui-jambes
Pair of covers for legrests

2536+166



Appui-bras (unitaire)
Armrest (unit)

2537



Housse pour appui-bras (unitaire)
Cover for armrest (unit)

2054-01



Appui-tête compatible avec sellerie uniquement
Headrest compatible with formed upholstery only

2055-01



Rallonge de dossier non compatible avec sellerie anatomique
Backrest extension not compatible with formed upholstery

1102-10



Appui-tête
Headrest

2051-10



Commande par pédale
Foot control
(réf./ref: 2050-10 + 2050-15)

2051-21



Commande par pédale
Foot control
(réf./ref: 2050-20+2050-30)

2051-31



Commande par pédale
Foot control
(réf./ref: 2050-50)

2056-02



Porte-rouleau réglable
Adjustable paper-roll holder
(350-800 mm)

85114-01



Paire de barrières
Pair of barriers
Non compatible avec les accessoires / Not compatible with accessories
166, 985-01, 2985-01

Lampes Lamps + 166



Se référer à la documentation
Refer to the literature

Choix de selleries non-feu M1
Antibactérien
Choice of M1 fire retardant
and antibacterial upholstery

Classic

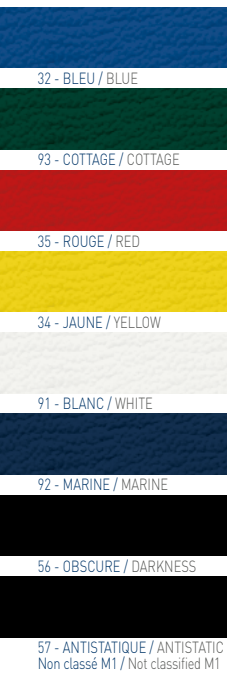

Vitamin

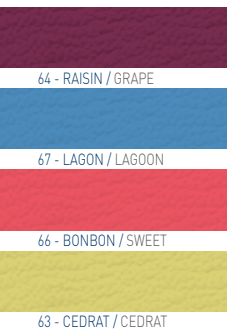

Cosy

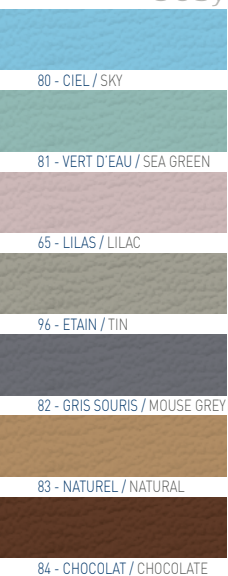

ANTIBACTÉRIEN / NON FEU M1 - ANTIBACTERIAL / M1 FIRE RETARDANT



Poids net
Net weight
Divan / Couch 83 kg
Sellerie / Upholstery 21 kg

Poids brut
Gross weight
Divan / Couch 121 kg
Sellerie / Upholstery 25 kg

Volume
Divan / Couch 0,96 m³
Sellerie / Upholstery 0,28 m³

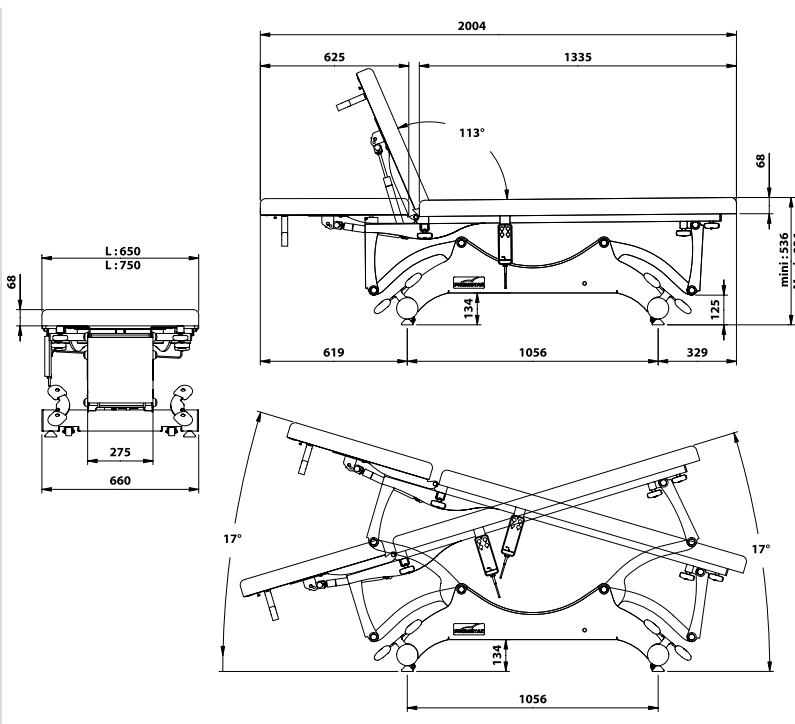

FE-51/16